

Dear Friends...



The future's bright...

First of all, a massive thank you to all who have been working at Ryecroft over the past few months. On our last visit we were so impressed to see the way that the work was coming together and very grateful for the way in which our needs have been considered – especially the colour schemes for our older three children!

Thank you too for the other ways in which people have been preparing for our arrival – we are very appreciative of your prayers in what is a very busy time for us. I write this letter surrounded by packing cases and we are so glad that by the time you read it we will be well on our way to being settled in.

Last month you had the photographs and the thumbnail sketches courtesy of Hannah, but it is now time to strike a different note. I am looking forward with anticipation to actually residing in Lindfield so that I can start to pray and work with you and get a sense of what God wants of us.

It has been a pleasure to work on the induction service with Ron and Michael, participate in an elders' weekend and plan the Sunday services for late

Summer and Autumn, but this has been from a distance. Over the years I have based my ministry on three platforms:

- 1) Church in community
- 2) Emphasis in Evangelism and
- 3) All member ministry.

As you can see from the first of these, there is no substitute for living and working in the community in which you are called to share the gospel – to get a heart for that community; to gain God's perspective through prayer and to formulate vision and strategy.

I don't know how far I will have got by the time we have a Church Meeting in the week following the induction, but I hope to be able to outline a few things and for us to be able to start to share and discuss where God's priorities might lie.

Colin Bones, minister

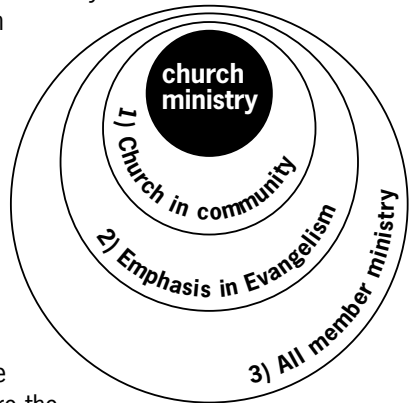

GoodNEWS

This magazine is produced by: Lindfield United Reformed Church, 50 High Street, Lindfield, West Sussex RH16 2HL.
© Lindfield URC 2003

Editor: David Tingley

<david@visualeclipse.co.uk> Tel: 01444 451024

Editorial Oversight: Hilary Shepherd

Additional Photography:

Chris & Nicola Saunders, John Barling

Copydate for the September 2003 edition is noon, Sunday 17th August 2003. All contributions should be given to the editor by this time via email, or paper copy can be placed in the "GoodNEWS" pigeon hole at the rear of the church. Please ensure that you include contact details in case of query.

Directory



Minister: Rev Colin Bones
50 High Street, Lindfield RH16 2HL
Tel: 01444 483803
Email: colin@lindfieldurc.org.uk

Secretary: Mr Ron Goodenough
"Downside" Stone Quarry Road,
Chelwood Gate RH17 7LS
Tel: 01825 740351; Fax: 01825 740157
Email: ron@rgoodenough.freeserve.co.uk

Assistant Secretary: Mrs Sue Waller
Tel: 01444 455047 Email: susanwaller@lineone.net

Treasurer: Mr Barry Piper
Tel: 01444 456823 Email: barrypiper@aol.com

Pastoral Assistant: Rev Mike Gardiner
Tel: 01444 482559 Email: mike.g@virgin.net

A list of serving Elders can be found in Who's Who?

Editorial



The summer is traditionally a time for music festivals all around the country; Reading, Greenbelt and Glastonbury. Well, now there is Grassrootz in Tunbridge Wells! In this issue we bring you the story behind it and information about the one-day event, starting at page 4.

Elsewhere in this summer issue, covering two months, are some top tips for staying safe in the sun, see page 13. Well worthwhile as you are out and about over the warmer months.

For those of you who like a little adventure, try bashing the snake over the head with your bible knowledge, in our rip-out supplement – Green Jelly. Many thanks to Clare Nibloe for her contributions on this one.

Other highlights to look out for include a special note of thanks from Terry Ward since retiring from the Boys' Brigade (page 25), Nikki Taylor's last few column inches (page 21) and I admit to watching too much reality TV, again on page 26!

Get out there amongst it, and tell us all about it.

David Tingley

Prayer Diary



SUN	<ul style="list-style-type: none"> • Pray for Colin, Catherine and family as they settle into "Ryecroft". • Ask that we might be filled with the Holy Spirit as we worship. • Uphold the staff in Junior Church, including temporary helpers in August.
MON	<ul style="list-style-type: none"> • Ask for God to bless all those away or going on holiday. • Pray for all teachers during the last few weeks of term. • Remember those awaiting important exam results.
TUE	<ul style="list-style-type: none"> • Pray for the work in the Brigades, and for sufficient staff in September. • Uphold the young people in Carpe Diem and 14+ Group. • Ask God to help bring these youngsters into a personal faith in Him.
WED	<ul style="list-style-type: none"> • Thank God for all Mike Gardiner has done as pastoral assistant. • Ask God to strengthen him, and to bless him and Jean as he retires! • Remember the many who have been bereaved recently within our fellowship.
THUR	<ul style="list-style-type: none"> • Pray for the various missionary organisations that we support. • Interserve (supported during July/August). • Tearfund Supper – 5th July. • Remember those Aid agencies seeking to help after disasters.
FRI	<ul style="list-style-type: none"> • Ask God to help the many trying to restore normal life in Iraq. • Uphold any facing major changes in their lives. • Pray for URCs in Eastbourne, Bexhill, Burgess Hill and Haywards Heath.
SAT	<ul style="list-style-type: none"> • Pray for Colin's Induction on 12th July. • Uphold all those taking part, either at the service or in the practical arrangements. • Pray for travelling mercies for all who attend.

Please ask God to bless and guide Colin as he begins his Ministry amongst us.

"We'll praise God for all that is past, and trust Him for all that's to come"



What's your flavour?

Grassrootz is a one-day music festival which will take place on the Eridge Estate, near Tunbridge Wells on Saturday 19th July 2003. 'What's your flavour?', this year's theme, sees a wide variety of Christian music from 'loud' to intimate acoustic sets. Here is an introduction to the local event.

The first ever Grassrootz took place in 2001 with just one stage. Last summer, 1,700 people were entertained on two stages throughout the day. On both occasions lives were touched by the presence of God and some profoundly changed.

As a result of last year's event we got this feedback – 'Last year (2002) at Grassrootz I had the best time of my life. I'm 17 and the highlight of the evening was when it rained when Yfriday started singing. I cried all night after that, because their song 'Rain' made me feel that God's power was working for all us youngsters and grown ups there! It felt amazing.'

2003 seeks to be bigger and better than what has gone before.

This year's theme, 'What's your flavour?' – explores the fact that there is such a wide range in musical tastes, not just among young people but children and adults as well. Grassrootz is making sure that everyone is catered for. That is very much

the emphasis – that everyone is welcome and is open to families and not just young people.

There will be performances from the London Community Gospel Choir, Steve and The Tribe (to name but a few). A second stage features Cephas, Audiogene, Ben Castle; plus there will be seminars from Elaine Storkey, Rob Lacey, and Tommy Baker the Christian football tricks expert and World Record Holder, who will not only be performing some of his tricks but also teaching them!

Very much a family day, there will be a kids' tent which will include a bouncy castle, ball pit and regular music and puppet shows, all provided by the local churches.

"I cried all night because the song 'Rain' made me feel that God's power was working for all us youngsters and grown ups there! It felt amazing."

For the bigger kids there will be an inflatable bungee run and jousting, while for the sporty people who can't wait for the next football session there is human table football! And for those who want to take things a little easier they can wander around the 'village area' visiting the wide range of stalls displaying crafts, books and music, face and nail painting, caricature portraits drawing and information on community and national issues.

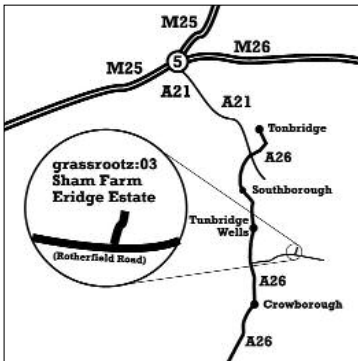

Grassrootz Festival Office,
 The Christ Church Centre,
 High Street,
 TUNBRIDGE WELLS,
 Kent TN1 1UT.
 Email: info@lifeandsoul.net
 Telephone: 01892 529505

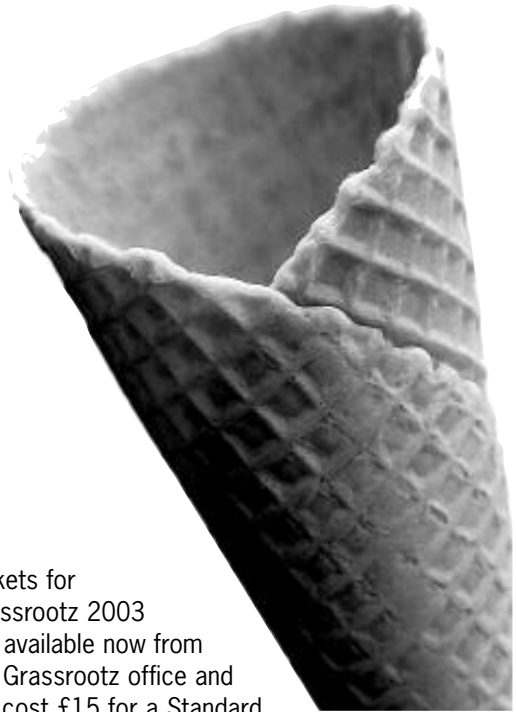

Tickets for Grassrootz 2003 are available now from the Grassrootz office and will cost £15 for a Standard Day Pass (£5 for Children's Pass – aged 3-11) and £10 for an Evening Only Pass (6.30pm – 11.30pm). Please make cheques payable to 'Grassrootz' and state how many tickets you would like and of which type.

Tickets can also be purchased on the day.

15-19? Like your music?
“BATTLE OF THE BANDS”
 Two heats: Heyworth School
 24th and 25th July
 Final: Clair Hall, 27th July.
Details at: www.tkc.org.uk/reverb



The vision of a festival

The vision of Grassrootz is to provide a safe place in which to fellowship, relax, have fun and experience God in His surroundings whilst uniting the churches and strengthening their links with the community. This has been seen more and more over the years with churches coming together as they realise the effectiveness and impact this event can have on our community.

As a local minister says “Unity between the churches is not only on God’s heart – it’s on His agenda! Grassrootz has helped bring more churches and Christians together and work alongside each other to provide not just something for the local community but something which will see God’s kingdom grow!”

The overall vision and direction of Grassrootz is all down to two people – Nick Cheesman and Simon Colenutt.

After attending ‘Cutting Edge’ in Littlehampton (the event from which bought us *Delirious*) Nick had the vision to bring something similar to Tunbridge Wells. October 1999 saw the



birth of ‘ID’ – a monthly youth event held at the Christ Church Centre in Tunbridge Wells. Four years later it now sees between 500 and 700 young people attend each month and goes from strength to strength.

Grassrootz was really a culmination of all the experience learnt through successfully running ‘ID’ and now is taking off in the same way. The professionalism of the event has enabled it to grow over the years with even more people hearing about it and wanting to come. In knowing this there is a sense of excitement of what is going to happen.

Nick, a graphic designer, is very much the visionary and Simon very much the practical person. It is through the hard work that they put into the event that not only makes it a great success but so professional as well.

Both of these events are only able to take place because of the growing support from the local churches. Behind the scenes it is a team of around 150 volunteers who are all willing to help before, during and after the day in whatever capacity they can to make sure that it runs smoothly. If it wasn't for this help then the event would not take place and it is through these volunteers giving up their time and energy that enables the vision of Grassrootz to be fulfilled.

Nick says 'After all the months of hard work that goes into putting the event together, when you see the crowd relaxing, enjoying themselves, worshipping God and through all of this lives being touched and changed, it makes it all worthwhile and at the end of the day (quite literally) we have to give the glory back to God.'

LCGC look forward to grassrootz

In 1982 a dream and a vision came alive. Revd Basil Meade, with the help of Lawrence Johnson, Delroy Powell and John Francis made a mark in history pioneering the first concert gospel choir in the UK. London Community Gospel Choir nurtured, over the next two decades, more than 200 members from all areas of London and its suburbs.

Basil Meade looks forward to Grassrootz as any gig: "Being at the Grassrootz festival will be another opportunity to share a very uplifting expression of faith in God with a new audience. It is another of many special moments that the choir has lived through over 21 years of being on the road promoting british gospel music. We intend to leave memories of true joyful, uplifting christian music that stimulates the emotions and touches the spirit of all listeners."

...and elsewhere in the world of pop music! —

Backsliding in the top ten

After topping the charts State-side Evanescence emerged in the UK music singles chart victorious too, reaching the number one spot some weeks back. However, debate seems to be raging about whether the group are 'Christian' or not!

The four-piece band, originally started in Arkansas during the late 1990s, topped the European charts with their single "Bring me to life" during June.

However, back in the States, Alan Meltzer, Chairman of their record label, Wind Up Records, issued a recall notice on their CDs on sale within Christian music outlets.

According to VH1.com, Meltzer sent a letter to Christian radio and retail outlets earlier this year to explain that despite the "spiritual underpinning that ignited interest and excitement in the Christian religious community," Evanescence are "a secular band, and as such view their music as entertainment". Therefore, he wrote, Wind-Up "strongly feels that they no longer belong in Christian markets".

Fans of the group have been surprised at this statement, saying that it looks as if they are trying to drop their Christianity now they are hitting the 'big time'.

In an interview with US Entertainment Weekly singer Amy Lee echoed her bandmate's puzzlement at their albums placement in Christian bookstores. "I guarantee that if the Christian bookstore owners listened to some of those songs, they wouldn't sell the CD."

Lee also made it sound as if she did not wish to be pigeon-holed into sharing shelf space with Christian acts like Jars of Clay and Steven Curtis Chapman.

It is made all the more unclear when you read an interview in 2000 when Amy Lee was quoted as saying: "The message we as a band want to convey more than anything is simple – God is love".

Whatever they have said though, they seem fairly keen to remain off the Christian music scene. Guitarist, Ben Moody, compares himself to the "the guy who was crucified next to Jesus" because "all I want you to do is remember me".

They mystery continues. Shame how things change.

David Tingley

Euthanasia debate

A passionate plea against the 'Euthanasia Bill' was made by the Bishop of St Albans, the Rt Revd Christopher Herbert in the House of Lords on Friday 14th June. He told Peers that the Patient (Assisted Dying) Bill was "individualism pushed to a horrifying and giddy conclusion" and, if passed, could "create a merciless society". Despite the speech by the Bishop and other opponents, the Lords agreed to give a second reading to the Bill which could give terminally ill people the right to be helped to die. The Bill, which does not have government support, is being championed by cross-bench peer Lord Joffe, who launched the debate.

Source: Christian Herald – the UK's only inter-church weekly. Subscribe on 01903 602100

Bble txts 4 the day

A Cardiff church leader has launched a bible verse texting service. Launching the W2LB text message service, Simeon Baker of Bethel Baptist Church, Whitchurch, said: "W2LB stands for 'wisdom to live by' and members get to start the day with an inspiring biblical quote sent as a text message to their mobile phones". Find out more at www.W2lb.com

Source: Christian Herald

Edwards to oversee good taste on TV.

Olympic gold medallist Jonathan Edwards has accepted a new role as part of a board, which oversees standards of taste and decency on television and radio.

A committed Christian, Edwards has become a representative on the content board of the communications regulator Ofcom – which formed from the merger of the Independent Television Commission, The Broadcasting Standards Commission and the Radio Authority.

The 37 year old son of a West Country vicar, Edwards – who presented Songs of Praise on Easter Sunday – will be responsible for championing the cause of listeners and viewers on issues as diverse as complaints about radio DJ phone-ins, to sex and violence on television.

The triple jump gold medallist credits his faith in God for his success and during the early stages of his athletics career he refused to compete on Sundays. One of nine part-time board members who work alongside full-time executives, his appointment has surprised some in the media industry.

Source: Christianity & Renewal magazine, June 2003

Bereavement

It is with sadness that we record the loss of **Reg Campling**. Reg had been a member of Lindfield URC for many years and had served as an elder and as church treasurer. His thanksgiving service on 5th June was a tribute to him and we offer our love and sympathy to Elsie, Graham, Lyn and all of the family. *“Great is thy faithfulness Lord unto me.”*

We also extend our love and sympathy to **Edna Flint** and her family and friends. Bill died on 31st May and his thanksgiving service was held on 10th June.

Thanks

We are so grateful to our church family for the love and support we have received in the days before and since the passing of our beloved Reg. His long and happy life greatly enriched ours and we thank the Lord for such a devoted husband, father and grandfather. We give thanks too for the loving care he received from all the staff in Compton House during his final weeks.

*Elsie, Graham, Lyn, Noel,
Jeremy and Melanie*

REG CAMPLING

We remember with gratitude and affection Reg Campling. The church was filled on 5th June with those who came to give thanks for Reg and his life within the family, in the church; the Bank of England; the Worshipful Company of Pewterers; Bowls Club and U3A as well as friends he had made from a wide area.

Reg was a member of this church for over 40 years and both as an elder and the treasurer for many years. Before this he had served in Watford and Southend-on-Sea. Reg served the Church with commitment and insight.

We remember Elsie who celebrated with Reg their 70th wedding anniversary a short while ago, and pray the she will, with all the family, know God's blessing.

Richard Tucker

Thank You

A note of thanks for the flowers and very kind thoughts that we have received from you all at the present time. Various lifts to and from hospital have been very much appreciated and we thank you very much once again for all your kind thoughts and prayers.

Sincerely yours in the Lord,
Elsie and Wally Plimmer

The Fellowship

We shall be holding our annual garden tea on Wednesday 23rd July at 3 pm at the home of Jessie Green, 15 Blackthorns. All are welcome, please come and join us for the afternoon. Should it be wet we will meet in the Church Hall.

Doreen Fowler

Heat helps sell more juice

Thank you to everyone who helped in any way with the refreshment tent on the common for Village Day. The wonderful weather resulted in much more juice being sold than coffee, but didn't seem to diminish people's appetite for a slice of cake! Whether you baked a cake, served tea, helped set up the tent, prayed for us or cleared up tables, we couldn't have served the village this way without you.

The profit made, which will be sent to Tearfund, was £290. Thank you.

Suzy Jacques

*The Common
& Garden*



Mike retires

On behalf of the Pastoral Group, and, indeed, the whole fellowship, I would like to express our very sincere thanks to Mike Gardiner for all he has done as the Church's Pastoral Assistant over the past 18 months.

His loving care of so many people passing through bereavement, sickness and difficult times has been so much appreciated, and his regular visits to the house-bound have also been a blessing to them. I'm sure it was not by accident that the Lord brought you here to 'retire' just as we were going into a pastoral vacancy! You have been a real 'God send' in every way. Thank you so much, Mike. May God continue to bless you and Jean as you minister in an unofficial capacity, perhaps in different ways. Mike is employed until 31st July.

Fiona Tingley

Sunday Morning Singers

It has been a privilege to sing at the Thanksgiving Services for two of our friends, Zena and Reg Campling, who were loyal and committed Christians.

Thanks to you all who were able to take part.

Dates for your diary

20th September afternoon
Revd Peter Mackintosh's Retirement Service at Worthing.

10th December afternoon.
Royal British Legion Lindfield Ladies section.

Other events including **Harvest** and **Christmas**, more about that in due course.

Rehearsal dates have been provided but we shall not be meeting on 11th July as it is the evening prior to the Induction Service.

Peter Swann

Balcombe United Reformed Church

Bramble Hill, Balcombe, RH17 6HR

Contact: Mrs Leonie Wren (01444 811253)

Our main services are held at 11am on the first and third Sunday of each month and the children usually go out to Sunday School during the second part of the service. Visitors are always welcome.



Speakers for July and August are as follows:-

6th July	Mike Gardiner – COMMUNION
20th July	Colin Bones
3rd August	Stuart Dew
17th August	Colin Bones

SPRING HARVEST NEEDS YOU!

Spring Harvest is one of Europe's largest Christian event organisers. Following a review of staffing needs, we require the following people to work behind the scenes at our Head Office in Uckfield.

Volunteers Administrator (part-time)

Assisting in the annual recruitment of over 1000 volunteer helpers for our Main Event, you will be able to demonstrate:

- excellent organisational ability
- good keyboard skills
- a systematic approach to routine jobs
- the ability to juggle multiple tasks

Applications are welcome for work in the region of 20 hours per week, with the flexibility to work additional hours on occasions.

Customer Service Advisor

Working as part of a dedicated Customer Service Team, you will contribute to the professional service offered to our guests. We are particularly looking for:

- previous customer service or travel industry experience
- good keyboard skills
- a professional communication manner
- an eagerness to learn new tasks

European language skills would also be an advantage. Applications are welcome for full-time work. A flexible approach to working additional hours on occasions would also be preferable.

Please email or write with full Curriculum Vitae to:

Stella Ellwood
Personnel Manager
Spring Harvest
14 Horsted Square
Uckfield

East Sussex TN22 1QG
stellae@springharvest.org

Spring Harvest. A Registered Charity. INVESTOR IN PEOPLE



TEARFUND SUPPER

on
Saturday 5th JULY
at 7.30pm

"In House" evening with two videos. 'Bright Sparks' about education in Ethiopia and another video concerning the disaster looming in Ethiopia and Eritrea due to drought and famine.

Tickets available from John Barling, Ron Goodenough, Trudy Biersteker, Iris and Bill Green.

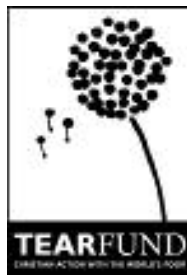

Be safe in the sun

Now that summer is here it is important to remember to stay safe in the sun! Hopefully these 'hot' tips will remind you how to look after yourself and your family...

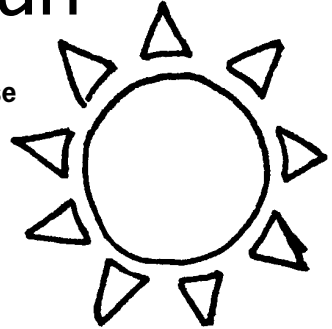

1. Avoid strong sunlight (between 11am – 3pm)



3. Cover up with loose clothing, protect your head with a hat and don't forget those sunglasses!



4. Don't forget your sun cream (at least Factor 15) – put it on well before you go out and remember to take it with you for regular top-ups

2. Keep babies out of the sun completely and apply sun cream to children over 6 months of age



5. Find shady, cool places when playing, walking, gardening or just reading. If your shadow is shorter than you are, then you're likely to burn!

Some facts

- 90% of all skins cancers can be attributed to the sun.
- Regardless of your skin's complexion, everyone is at risk to get skin cancer.
- It can take less than 10 minutes for a child's skin to burn.
- Even on a cloudy day, 80 percent of the sun's ultraviolet rays pass through the clouds.
- There is no safe way to tan. A suntan is the skin's response to an injury.

July / August diary

NB – During this holiday period the worship leader may not be as stated but the musicians of the relative worship group should be

3rd

Thursday House Groups

5th

Saturday 7.30pm Tearfund Supper

6th Sunday

9.30am Richard Walters
& Ron Goodenough
11.0am Ron Goodenough
6.30pm Barry Piper

9th

Wednesday 12.30pm Lunch Fellowship

11th

Friday 12.30pm Lunch Fellowship

12th

Saturday 5.0pm Induction of
Colin Bones

13th Sunday

9.30am Richard Walters
& Colin Bones
11.0am Colin Bones
6.30pm Communion
David Nibloe &
Colin Bones

16th

Wednesday 1.15pm 'Christianity
made clear' – Free talk at
Clair Hall

17th

Thursday 8.0pm Church
members'
Meeting

20th Sunday

9.30am Richard Walters
& Colin Bones
FAIR TRADE STALL TODAY
11.0am Mike Gardiner
6.30pm David Nibloe &
Colin Bones

22nd

Tuesday 7.45pm Ladies 'In Touch'

23rd

Wednesday 3.0pm The Fellowship
7.45pm Elders' Meeting

24th

Thursday 8.0pm Monthly Prayer
Meeting

27th Sunday

9.30am Richard Walters
& Colin Bones
11.0am Communion
Colin Bones
6.30pm David Nibloe &
Colin Bones

August

3rd Sunday

9.30am David Nibloe &
Colin Bones
11.0am Colin Bones
6.30pm Colin Bones
7.45pm 'The wife of
Bath' performed on
Lindfield Common

10th Sunday

- 9.30am** David Nibloe & Colin Bones
11.0am Colin Bones
6.30pm Communion
 Richard Walters & Colin Bones

17th Sunday

- 9.30am** David Nibloe & Colin Bones
 FAIR TRADE STALL TODAY
11.0am David Walters
 12noon Copy Date for Sept. GoodNEWS
6.30pm Richard Walters & Colin Bones

24th Sunday

- 9.30am** David Nibloe & Ron Goodenough
11.0am Communion
 Ron Goodenough
6.30pm Richard Walters & Brian Stone

26th

Tuesday time tbc Ladies 'In Touch'

28th

Thursday 8.0pm Monthly Prayer Meeting

31st Sunday

- 9.30am** David Nibloe & Stuart Dew
11.0am Stuart Dew
6.30pm Richard Walters & Derek Heath

Sunday services explained...

The **9.30am service** is an opportunity for all age groups to join in a relaxed informal time. There is a crèche, and after about 20 minutes children and young people up to age 14 go out to their own groups on most Sundays.

Coffee is normally served between the morning services and after the evening one.

The **11.00am service** is usually more set and formal.

At **6.30pm** it is sometimes a celebration, sometimes a quieter ministry time and sometimes an open communion service or something quite different!

Personal prayer is available after every service. Prayer requests and brief statements of praise for answered prayer can be put in the red book on the concourse table. We can also offer personal prayer ministry at home or in hospital.

We **do not take up an offering** during the services, but all those wishing to give are invited to place a gift in one of the bowls at the doors before or after the service. Thank you.

Cassette **recordings of services** can be borrowed free from the church.

John 10v 1-21

¹"I tell you the truth, the man who does not enter the sheep pen by the gate, but climbs in by some other way, is a thief and a robber. ²The man who enters by the gate is the shepherd of his sheep. ³The watchman opens the gate for him, and the sheep listen to his voice. He calls his own sheep by name and leads them out. ⁴When he has brought out all his own, he goes on ahead of them, and his sheep follow him because they know his voice. ⁵But they will never follow a stranger; in fact, they will run away from him because they do not recognise a stranger's voice." ⁶Jesus used this figure of speech, but they did not understand what he was telling them.

⁷Therefore Jesus said again, "I tell you the truth, I am the gate for the sheep. ⁸All who ever came before me were thieves and robbers, but the sheep did not listen to them. ⁹I am the gate; whoever enters through me will be saved. He will come in and go out, and find pasture. ¹⁰The thief comes only to steal and kill and destroy; I have come that they may have life, and have it to the full.

¹¹"I am the good shepherd. The good shepherd lays down his life for the sheep. ¹²The hired hand is not the shepherd who owns the sheep. So when he sees the wolf coming, he abandons the sheep and runs away. Then the wolf attacks the flock and scatters it. ¹³The man runs away because he is a hired hand and cares nothing for the sheep.

¹⁴"I am the good shepherd; I know my sheep and my sheep know me – ¹⁵just as the Father knows me and I know the Father – and I lay down my life for the sheep. ¹⁶I have other sheep that are not of this sheep pen. I must bring them also. They too will listen to my voice, and there shall be one flock and one shepherd. ¹⁷The reason my Father loves me is that I lay down my life – only to take it up again. ¹⁸No one takes it from me, but I lay it down of my own accord. I have authority to lay it down and authority to take it up again. This command I received from my Father."

¹⁹At these words the Jews were again divided. ²⁰Many of them said, "He is demon-possessed and raving mad. Why listen to him?"

²¹But others said, "These are not the sayings of a man possessed by a demon. Can a demon open the eyes of the blind?"

The parable of the shepherd

The setting of this much-loved teaching would have been familiar to Jesus' original listeners.

In the Middle East, sheep were kept overnight in an open enclosure, sometimes housing several flocks. The shepherds would keep watch overnight (remember the Christmas carol?), acting as a gate to keep the sheep in and the wolves and thieves out. In the morning, each would call his own sheep and they would follow him out to pasture. Because of the danger of predators, the shepherd would remain close to his flock. So the picture of recognising Jesus' voice and following him is a very reassuring one, especially as there were spiritual predators – John did not divide his story into chapters, and the warnings against false shepherds follow directly Jesus' confrontation with his bitter opponents.

But there is a deeper significance to Jesus teaching, ready for anyone with the time to do some homework. Read through the short Psalm 137 and try to enter into the anguish of the Jews who were prisoners of war in Babylon some 600 years before Jesus' ministry, then look at Ezekiel 34v11–13 for God's wonderful promise (given in Babylon) to be a shepherd to his people. Jesus' Jewish hearers

would have heard Jesus' teaching against the background of the Old Testament: "I am the Good Shepherd" – yes, the one promised all those years ago by Ezekiel when we were in the depths of despair! Very significantly, by saying "I am..." Jesus is taking the astonishing step of identifying himself with God, and one of John's aims is to highlight sayings like this. There are in fact seven "I am" sayings of Jesus in John's Gospel. See if you can find them all! (two are in this passage) Not surprisingly, Jesus' astounding claims for himself provoked opposite reactions – see verses 19–21. It's the same today. As C.S Lewis pointed out, Christianity is either false, and therefore of no importance, or true, and of infinite importance; the one thing it cannot be is moderately important. And it's clear from John's Gospel that all hinges on whether Jesus really is who he said he was.

The secret is listening to Jesus' voice (v16) – the voice that still speaks to us through the pages of this wonderful Gospel of John. Then the decision is yours: dismiss him... or recognise him as the Good Shepherd who laid down his life for you, the gateway for you to enter and find pasture – and to live life to the full!

Mike Gardiner

Interserve

During July and August we shall be featuring the work of Interserve, a Christian missions organisation dedicated to serving the peoples of Asia and the Arab world.

On 6th July during our Sunday morning services, Interserve representative Christine Hunt will be telling us about its work today. Do come along and hear Christine. Further information will be available through the display on the missions board in the church concourse, or why not visit the website at www.interserveonline.org.uk. Anyone wishing to support the work financially may use one of the special missions envelopes available on the table by the display and placing it in the weekly offering.



Interserve's Dave Taylor, a former member of All Saints Parish Church in Lindfield, tells the story of Sarah, to inspire other would be 21st century "missionaries".

"As a committed Christian in her teenage years, Sarah had a desire to work with marginalised people overseas. In some small way, Sarah wanted to serve other people before taking up her place at university. So she did some research, applied to Interserve, and was accepted onto their short term programme, On Track, seconded to Oasis India."

Sarah takes up the story.

"It was October when I flew out on my own and met up with a team of others, from different countries. I went to Mumbai (formerly Bombay) with no fears, as I knew God was taking me down a new and exciting path. I admit I did feel a little apprehensive, but my excitement far exceeded that."

In Mumbai, Sarah became a member of a small team helping with a church youth group, and also had the opportunity to be involved with Oasis' ministry to the urban poor.

"I helped at Jacob's Well, a tailoring company set up to offer vocational training and employment to women, old and young, from the slums around the city" she recalls. "The women who worked there were a testimony themselves. I will never forget how they



thanked and praised God before they started work in the mornings.”

So, what made a young woman leave the relative comforts of Dorset, to work with slum dwellers in an Indian metropolis?

Sarah explains:

“Yes, Mumbai is a hot, smelly, busy and poverty-stricken city. Somehow, though, I knew that God wanted me there for my gap year. So, I had to trust Him. It wasn’t easy all of the time. There were ups and downs, times when I wanted to jump on the next plane home. Situations in which I messed up.

“But I can honestly say that my faith in God grew so much as a result of serving Him and the people of Mumbai. My relationship with the Lord is now far deeper and closer than I ever realised it could be.”

An experience to be recommended? Sarah’s reply is emphatic.

“Going to Mumbai was an experience I will never forget. It was a challenge. I came closer to God and I met people who gave me a greater understanding of what He is like and what I am like. The people out there supported me in a way I never expected and my church and friends back home were a great encouragement to me. It was brilliant.”

6th July



Don't miss the opportunity to hear Interserve's Christine Hunt at our morning services.

Twenty more questions

GoodNEWS takes a probing glimpse into the minds of those who come to the church! Twenty Questions gives you a chance to guess the interviewee and learn a bit more about them too! This month's guest is revealed on the foot of Page 27.

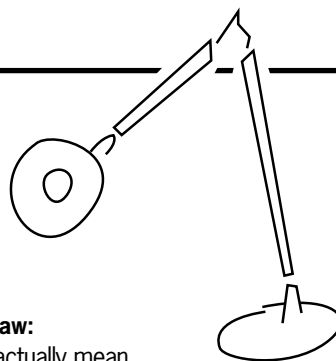

- 1. What is your best memory from your school days?**
Leaving.
- 2. Favourite TV programme?**
Coronation Street.
- 3. If 'Changing Rooms' were to visit your home, which room would you ask them to redecorate?**
Kitchen.
- 4. Banoffee Pie, Apple Crumble or Fruit Salad?**
Banoffee Pie.
- 5. Which service do you frequent most often?**
9.30.
- 6. Have you been trained in a specific line of work, if so what?**
Teaching.
- 7. What one person do you think has most influenced your desire to follow Christ?**
Reverend Norman Wright, Romford 1958.
- 8. Who would you most want to have a 'one-to-one' conversation with (past or present)?**
Mary Wollstonecraft.
- 9. Do you qualify for a free Bus Pass?**
Not quite!
- 10. Shoe size?**
5.
- 11. Create a new law:**
Equal rights to actually mean equal rights.
- 12. Mug or cup & saucer?**
Mug.
- 13. Do you have a personal email account?**
No.
- 14. What is the best strength of the Christian church?**
All are welcome.
- 15. Describe the 'Christian life' in no more than three words.**
Not always easy.
- 16. Most romantic moment?**
Yet to come!
- 17. Best moment of fame?**
First angel in a nativity play when I was 5.
- 18. Give one piece of wisdom to the next generation.**
Make the most of now.
- 19. What is the greatest difference between your life now and before you became a Christian?**
I'm not so quick to judge others.
- 20. Glasses, contact lenses or none?**
Glasses.

Go on, take the 20 Questions challenge
at www.lindfieldurc.org.uk

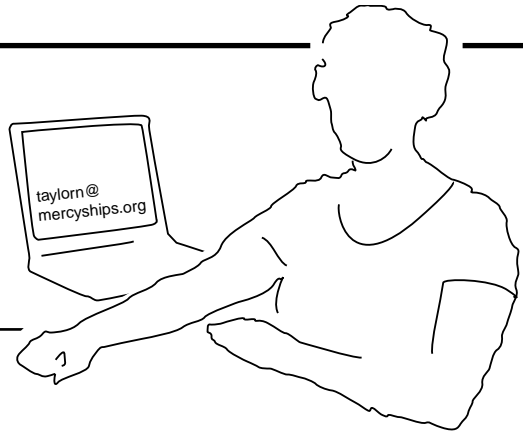

Mercy Ships Freetown, Sierra Leone

Summer in England is a lovely thing... I arrived back after a long journey from Freetown, Sierra Leone to London Gatwick. Mum and Dad were there to meet me as Dad had come in from Dubai the day before – always nice to be met by people you love! I spent the first few days at home sleeping. I am always so exhausted when I get back from Sierra Leone as I push myself to get all the million and one things done that I need to do before I leave and I get very little sleep.

Shopping is so difficult too. Groceries and the choice available bewilders me and I often come back with an empty basket and try again the following day. I think the hardest thing is noticing the change in our national character. People seem so materialistic here – need to have the matching Gucci shoes and handbag – and so angry, swearing at people and cutting people up on the roads for simple mistakes. The sarcasm seems to have grown to be a national pastime.

So after 48 hrs of sleep and eating I was dragged out of bed at 3.00am to drive up to Oban in Scotland to cross over to Iona for a week of holiday/retreat with various members of the four parishes of our church and the Methodist minister and her daughter. We certainly had plenty of Clergy. It was lovely. The sea was that fabulous tropical turquoise that I have become accustomed to, normally it makes me want to rip off my clothes and dive in. Iona was a bit chilly for that. After a tentative paddling of the toes I kept well under wraps. We did the pilgrimage around the island and had daily services in the Bishop's house where we were staying. It was a good time to relax and eat well and get my spiritual dominoes in order.

I am not sure what God has next for me so life is a little uncertain at the moment. I am taking a break and having a think. I am finishing up work for Mercy Ships writing a few reports and proposals and answering daily emails (Where is the...? What do I do with the...? I cant print what do I do? etc) So I shall be officially finished with Mercy Ships in August.

I hope to do a little touring and am awaiting an invitation from my friends at Lindfield when they are ready to hear the last installment of my Sierra Leone experience.

Working in the world _____



More 'goings on' on the pond

Since we last reported the arrival of a young mute swan on Lindfield's pond earlier in the year (March GoodNEWS), excited pond watchers have seen a second, slightly older, swan come and go, a hopeful heron stage an occasional vigil on one of the islands and a pair of *Branta Canadensis* (Canada geese to the rest of us) set up home.

All passing eyes were on the island nesting site until in late May when four (or was it five?) fluffy, yellowish brown goslings emerged on their maiden cruise around the pond, chaperoned by their proud parents. It appears that only three youngsters have survived as we go to press, but they certainly look healthy and are growing by the day. They should be able to fly after about nine weeks but then usually remain as a family until the spring.

These large North American birds with their characteristic black head and neck and white chin patch were first introduced to Britain in 1665 as an addition to the waterfowl collection of King Charles II at St. James' Park. Others followed as decorative birds for parkland

lakes. Numbers remained low until the 1950s when they started to increase significantly, and by 1976 there were an estimated 19,000 in the UK. The 1991 census recorded 63,581 Canada geese. However, evidence suggests that the population in urban areas is now levelling out due to competition for nesting sites.

If you're down in the village listen out for the occasional trumpet-like honking call of the adult geese. The goslings may look cute and cuddly, but don't get too close – mum and dad will never be very far away!

John Barling

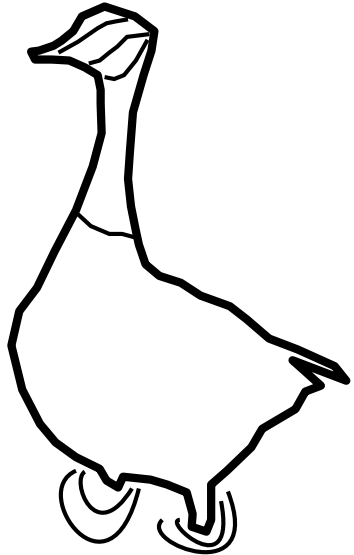

The back pages

Dear Friends

I expect most of you will probably know by now that I retired from our Boys' Brigade Company at the end of 2002 after 30 years service. We had our ups and downs as any organisation would, but I can honestly say that I enjoyed it all. It was a great experience and I have some very fond memories. I feel sure that God spoke to me about joining back in 1972 and I know He was with me throughout my time in the Company especially the last 17 years when I was captain. Paddy Lay (our founding captain) was a great inspiration and gave me so much help. When I wasn't sure about taking over the captaincy in 1986, he had confidence in me that I would be alright.

Of course my thanks go to all the other officers, helpers and 'others' who gave their time, without whom there would not have been a Company. My thanks also go to all our friends in the church who over the years have given so much practical and prayer support. (We've had some great jumbles!)

The Boys' Brigades objective is THE ADVANCEMENT OF CHRIST'S KINGDOM AMONG BOYS, and the biggest thrill of working in the Company has been to see so many of our boys finding Jesus Christ to be their friend and saviour.

Thanks once again for your help and support and I pray that you will continue to give that support, not only in prayer but by attending the BB functions that are run at church. Please pray for the ongoing work in the Company and for those running it, especially Geoffrey Cocksedge, as he heads up the team. Please pray also that more boys will want to find Jesus as their friend and saviour.

I still help with Boys' Brigade in our Battalion as a Vice President, so I keep in touch.

My last thanks go to Alison who has done so much to help and support me. We even moved our wedding date in 1978 so that Paddy and I could fit in a BB camp!

With love, Terry Ward

HYMNS FOR ALL OF US...

The Dentist's Hymn:
Crown Him with Many Crowns

Weatherman's Hymn:
There Shall Be Showers of Blessings

Contractor's Hymn:
The Church's One Foundation

The Tailor's Hymn:
Holy, Holy, Holy

The Golfer's Hymn:
There's a Green Hill Far Away

The Politician's Hymn:
Standing on the Promises

Optometrist's Hymn:
Open My Eyes That I Might See

The Tax Inspector's Hymn:
I Surrender All

The Gossip's Hymn:
Pass It On

The Electrician's Hymn:
Send The Light

The Shopper's Hymn:
Sweet Bye and Bye

The Massage Therapists Hymn:
He Touched Me

Are you watching Big Brother?

Television's latest reality TV offering is the fourth series of Big Brother on Channel 4. This year, one of the 12 housemates – who stay in the camera-ridden house for nine weeks potentially – is a Christian. So is it a good thing or not?

You know what it is like if ever there is a Christian featured in a soap opera – they are either pathetically 'wet' or are a secret murderer with a decidedly dodgy past!

So as I was watching the first night of coverage for Big Brother 4, I had a mixed reaction to the news that Cameron Stout goes to Orkney Baptist Church.

However those who have been watching the show so far, will have seen that he is faring pretty well amongst the other housemates. In fact, when writing this piece (Day 22) Cameron was ranked 4th in a popularity poll in the house.

He seems to be portraying a pretty strong picture of being a Christian. Whilst Cameron has been fun in the house, he seems to have managed to avoid late-night drunken binges and keep out of certain topics of conversation.

One contributor to an online discussion forum wrote: "Too

many people make snap judgements about how Christians are but Cam is OK....he's normal and fun but obviously has deeply held beliefs."



They went on: "To be honest, I thought once people, especially the media, got hold of the fact that he is a Christian they would shred him to bits and just dismiss him as a bible basher etc. But he's not fitted with stereotyped images and is very popular."

Cameron has also been causing a bit of a stir closer to his home too. Orkney newspaper, The Orcadian, has carried numerous stories supporting the local 32 year old. "He has been finding solace in his Bible. The Christian retreated to the boys' bedroom and read aloud passages from the book, interestingly enough it was passages about food – something which is in short supply in the house at the moment."

Only time will tell how he does, but it is great to have a positive example of christian living on our TV screens!

David Tingley

Thank you from Mercy Ships

Thank you for your gift of £1500 which will be used to bring hope and healing to many in developing nations.

God bless you! We hear these words so often, sometime as casually as when a person sneezes. But we were deeply humbled to hear of these words spoken last month by a special mother in Togo, West Africa, where the Mercy Ship Anastasis is concluding its outreach.

Juliette looked down at her one-year-old's deformed feet and hands and said, "People aren't usually born like him, but he came this way." As she spoke, she lovingly held her son with hands that were equally as deformed and twisted as those of little Josué.

Juliette spoke from years of living with her own deformities. "When he was born, I was so upset I went to my pastor for help. He said his job wasn't helping deformed people."

Finally, she heard about Mercy Ships. Josué received the needed surgery to correct his deformities. Dr. Tertius Venter explained Josué will need additional surgery when he grows older, saying "Hopefully we will be able to help him if the Mercy Ship returns in 2004." Now hopeful that her son will be able to lead a normal life, Juliette exclaimed, "May God bless you for what you have done for my son."

So, congregation, may God bless you! I echo Juliette's blessing in thanking you for your gift to Mercy Ships. Your support is bringing healing to thousands like Josué. God bless you!

Yours sincerely, *John Bradford*
Exec. Director of Mercy Ships

Church closure. The Church of the Good Shepherd, Franklands Village, held its final service on 29th June. The move, despite petitions, is to cut costs across the St Wilfred's Parish.

The Twenty Questions guest this month was: Rosemary Dew. Why don't you take the challenge? Email the editor your answers, or do it on the church website www.lindfieldurc.org.uk.

Flower Rota

		Arranging	Distributing
July	6	Zoe Mcquillin	Jacqueline Wood
	13	Induction	Iris Bingham
	20	Gladys Porter	Fiona Tingley
	27	Fiona Tingley	Heather Swann
Aug.	3	Audrey Saunders	Vera Dorton
	10	Winifred Scopes	Sue Tester
	17	Lucy Thom	Dorothy Forster
	24	Lyn Tucker	Betty Peter
	31	Janet Wade	Jacqueline Wood
Sept.	7	Joan Durrant	Iris Bingham
	14	Mies Brock	Fiona Tingley
	21	Carol Walters	Heather Swann
	28	Harvest Festival	Vera Dorton

Church activities

SUNDAY WORSHIP:

- 9.30am Service for all the family, including crèche and Junior Church
(Most weeks, children leave after 20 minutes for their own activities)
- 11.00am Morning Worship
Holy Communion (4th Sunday)
- 6.30pm Evening Service
Holy Communion (2nd Sunday)

Healing Services as announced

PRAYER MEETINGS:

- Mon 9.15am An Hour of Prayer
- Wed 9.45am Short Service of Intercession
- Thur 8.00pm Church Prayer Evening
(4th Thursday)
- Fri 7.30am Prayer Meeting in the Lounge

REGULAR ACTIVITIES:

- Sun 6.30pm Sunday Evening Youth Group
- Mon 6.30pm Boys' Brigade – Junior Section (8–11 years)
- Tue 10.00am Stepping Stones
(Parents and toddlers)
- 6.15pm Girls' Brigade – Juniors, Seniors & Brigaders
- 7.45pm In Touch (4th Tuesday)
- Wed 2.45pm The Fellowship (4th Wed.)
- Thur 10.00am Pop-In (for coffee and a chat)
- 8.00pm Church Meeting (2nd Thur.)
- Fri 5.30pm Boys' Brigade – Anchor Boys (5–7 years)
- 7.30pm Boys' Brigade – Company Section (11+ years)

House Groups normally meet 1st and 3rd Thursday

**The church is open Monday to Saturday
from 10.00am to 1.00pm**

Phonebook



Church Telephone Number:

01444 484620

Boys' Brigade:

Geoffrey Cocksedge
01444 474007

Cradle Roll:

Sue Tester 01444 482810

Flowers:

Betty Billins 01444 484494

Girls' Brigade:

Margaret Luscombe
01444 412156

Hall Letting Secretary:

Audrey McKee 01444 415031

In Touch:

Sue Waller 01444 455047

Lunch Fellowship:

Wednesday:
Iris Green 01444 484117
Friday: Gwen and
Derrick Hillman 01444 456963

Magazine: Editor:

David Tingley 01444 451024

The Fellowship:

Jessie Green 01444 452708
Roy Billins 01444 484494

Stepping Stones:

Janet Goodenough
01825 740351

Transport:

Tina Elphick 01444 484440

Youth and Children's Work

Co-ordinator:

Rob Biersteker 01444 440835

Junior Church Co-ordinator:

Clare Nibloe 01444 484683